

Specifications

Nominal Voltage		2 V
Rated capacity(10HR)		800Ah
Dimension	Length	410 ± 2mm (16.14inch)
	Width	175 ± 2mm (6.89inch)
	Height	330 ± 2mm (12.99inch)
	Total Height	367 ± 2mm (14.45inch)
Approx. Weight		53kg (116.8lbs) ± 3%

Dimensions

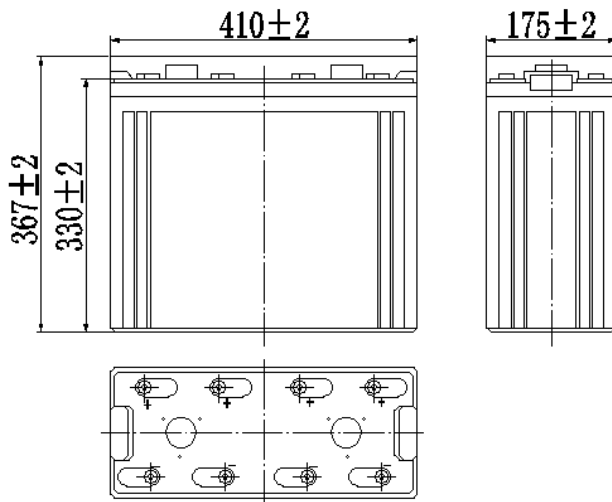

Terminal

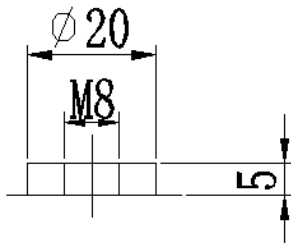

Characteristics

Capacity (25°C)	10HR(1.8V)	800 Ah
	3HR(1.80V)	630Ah
	1HR(1.75V)	470Ah
Terminal type		T20
Internal resistance (Fully charged, 25°C)		Approx. 0.35mΩ
Capacity affected by temperature (10HR)	40°C	102%
	25°C	100%
	0°C	85%
	-15°C	65%
Self-discharge (25°C)	3 month	Remaining Capacity: 91%
	6 month	Remaining Capacity: 82%
	12 month	Remaining Capacity: 65%
Nominal operating temperature		25°C ± 3°C (77°F ± 5°F)
Operating temperature range	Discharge	-15°C ~ 50°C (5°F ~ 122°F)
	Charge	-10°C ~ 50°C (14°F ~ 122°F)
	Storage	-20°C ~ 50°C (-4°F ~ 122°F)
Float charging voltage(25°C)		2.25 to 2.30V Temperature compensation: -3mV/°C
Cyclic charging voltage(25°C)		2.40 to 2.50V Temperature compensation: -5mV/°C
Maximum charging current		160A
Maximum discharge current		4400A(5 sec.)
Designed floating life(20°C)		15 years

Construction

Component	Positive plate	Negative plate	Container	Cover	Separator	Electrolyte	Safety valve	Terminal
Raw material	Lead dioxide	Lead	ABS	ABS	AGM	Sulfuric acid	Rubber	Copper

Constant Current Discharge Characteristics (A, 25°C)

F.V/TIME	15min	30min	60min	2h	3h	4h	5h	6h	8h	10h	20h
1.60V	1168	764	529	309	223	178	153	132	104	85.9	45.3
1.65V	1140	749	513	308	221	177	152	131	103	85.8	45.2
1.70V	1098	726	497	305	220	176	151	130	103	85.5	45.1
1.75V	1060	709	482	300	218	175	150	129	102	85.0	44.8
1.80V	1004	683	466	293	212	169	146	125	99.0	84.4	44.5

Constant Power Discharge Characteristics (Watt, 25°C)

F.V/TIME	15min	30min	60min	2h	3h	4h	5h	6h	8h	10h	20h
1.60V	2137	1429	1005	597	437	349	302	260	207	171	90.6
1.65V	2085	1401	975	594	434	347	300	258	206	171	90.5
1.70V	2009	1358	945	588	431	345	298	257	205	170	90.2
1.75V	1940	1325	915	580	428	342	296	255	203	169	89.7
1.80V	1838	1276	885	565	415	332	287	247	197	168	89.0

Note: The above characteristics data can be obtained within three charge/discharge cycles.

Discharge Characteristics(25°C)

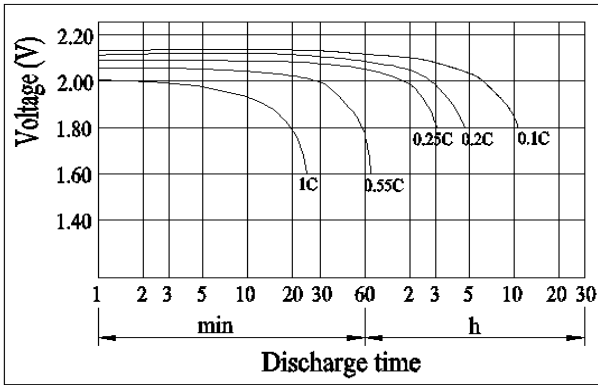

Charging Characteristics(25°C)

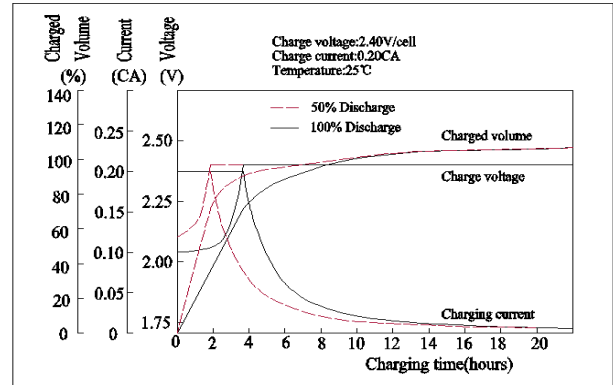

Effect of Temperature on Capacity

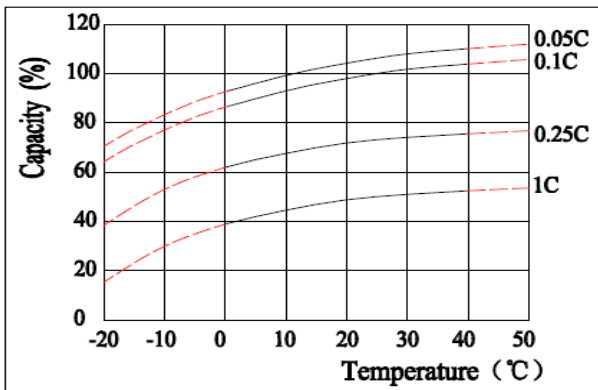

Self-discharge Characteristics

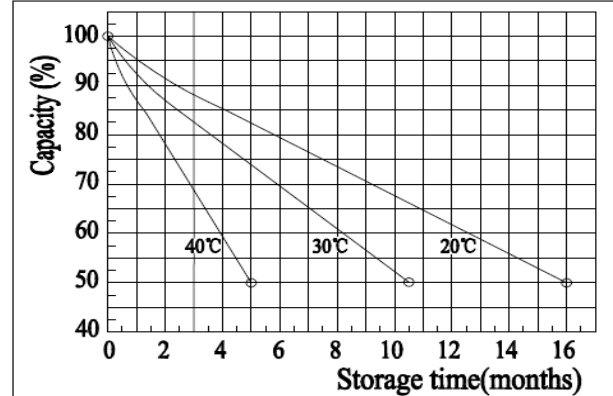

Floating Life on Temperature

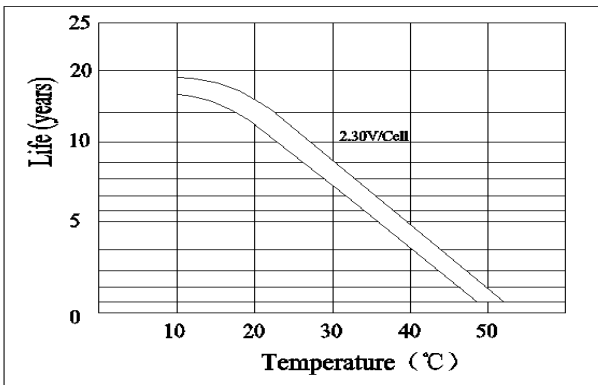

Cycle Life on D.O.D(25°C)

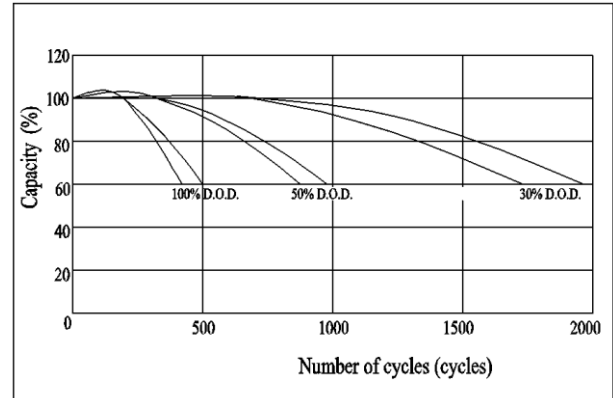

The Relationship for Open Circuit Voltage and Residual Capacity (25°C)

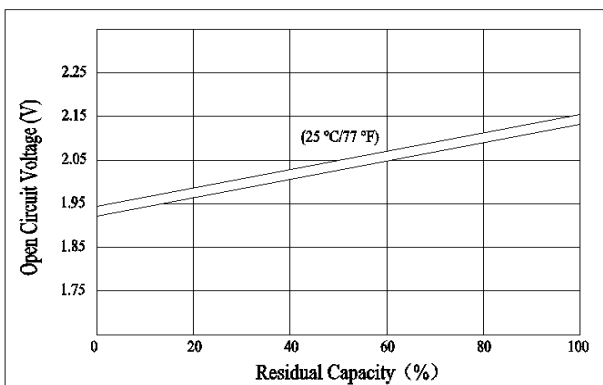

The Relationship for Charging Voltage and Temperature

