

Specifications

Nominal Voltage		2 V
Rated capacity(10HR)		500Ah
Dimension	Length	241±2mm (9.49inch)
	Width	171±2mm (6.73inch)
	Height	330±2mm (12.99inch)
	Total Height	365±2mm (14.37inch)
Approx. Weight		31.5kg (69.4lbs)±3%

Dimensions

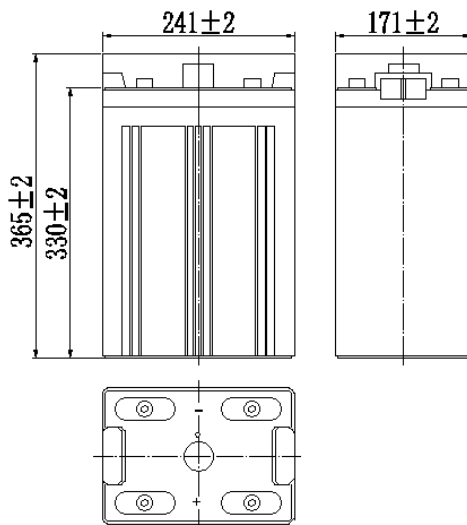

Terminal

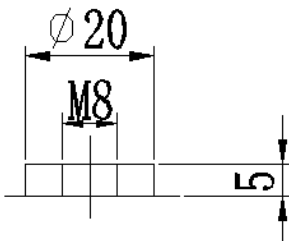

Characteristics

Capacity (25°C)	10HR(1.8V)	500 Ah
	3HR(1.80V)	390Ah
	1HR(1.75V)	300Ah
Terminal type		T20
Internal resistance (Fully charged, 25°C)		Approx. 0.5mΩ
Capacity affected by temperature (10HR)	40°C	102%
	25°C	100%
	0°C	85%
	-15°C	65%
Self-discharge (25°C)	3 month	Remaining Capacity: 91%
	6 month	Remaining Capacity: 82%
	12 month	Remaining Capacity: 65%
Nominal operating temperature		25°C ± 3°C (77°F ± 5°F)
Operating temperature range	Discharge	-15°C ~ 50°C (5°F ~ 122°F)
	Charge	-10°C ~ 50°C (14°F ~ 122°F)
	Storage	-20°C ~ 50°C (-4°F ~ 122°F)
Float charging voltage(25°C)	2.25 to 2.30V Temperature compensation: -3mV/°C	
Cyclic charging voltage(25°C)	2.40 to 2.50V Temperature compensation: -5mV/°C	
Maximum charging current	100A	
Maximum discharge current	3000A(5 sec.)	
Designed floating life(20°C)	15 years	

Construction

Component	Positive plate	Negative plate	Container	Cover	Separator	Electrolyte	Safety valve	Terminal
Raw material	Lead dioxide	Lead	ABS	ABS	AGM	Sulfuric acid	Rubber	Copper

Constant Current Discharge Characteristics (A, 25°C)

F.V/TIME	15min	30min	60min	2h	3h	4h	5h	6h	8h	10h	20h
1.60V	737	482	334	195	141	112	96.8	83.3	65.7	54.2	28.6
1.65V	719	473	324	194	140	112	96.2	82.8	65.3	54.1	28.5
1.70V	692	458	314	192	139	111	95.5	82.2	64.8	54.0	28.5
1.75V	669	447	304	190	138	110	94.9	81.6	64.4	53.6	28.3
1.80V	634	431	294	185	134	107	92.0	79.2	62.5	53.3	28.1

Constant Power Discharge Characteristics (Watt, 25°C)

F.V/TIME	15min	30min	60min	2h	3h	4h	5h	6h	8h	10h	20h
1.60V	1348	902	634	377	275	220	191	164	131	108	57.2
1.65V	1316	884	615	375	274	219	190	163	130	108	57.1
1.70V	1267	857	596	371	272	218	188	162	129	107	56.9
1.75V	1224	836	577	366	270	216	187	161	128	107	56.6
1.80V	1159	805	558	356	262	210	181	156	124	106	56.2

Note: The above characteristics data can be obtained within three charge/discharge cycles.

Discharge Characteristics(25°C)

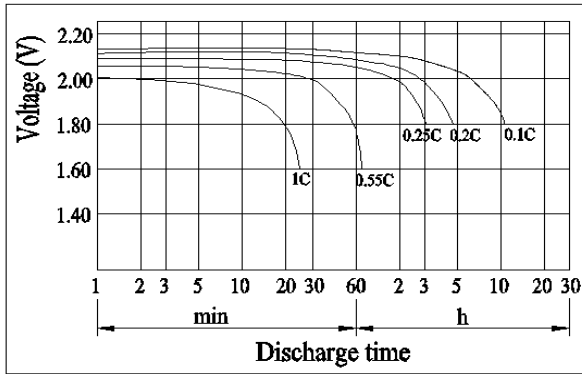

Charging Characteristics(25°C)

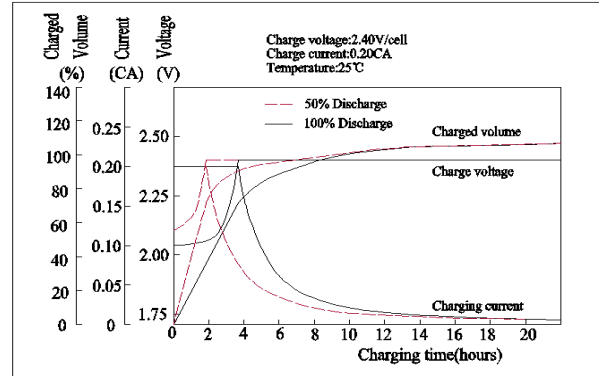

Effect of Temperature on Capacity

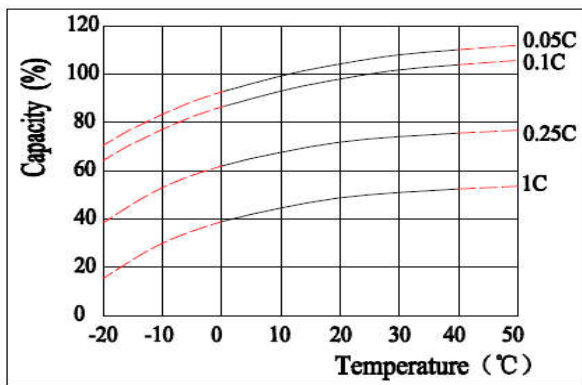

Self-discharge Characteristics

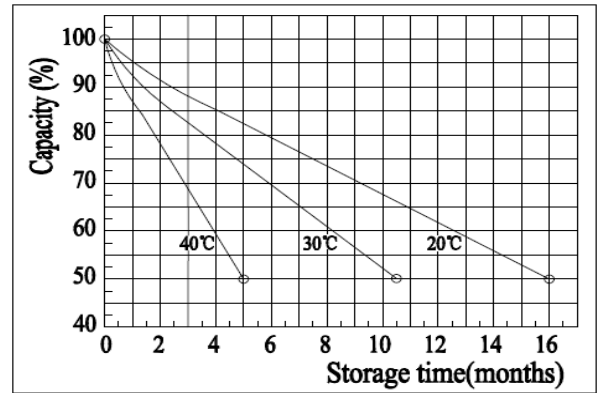

Floating Life on Temperature

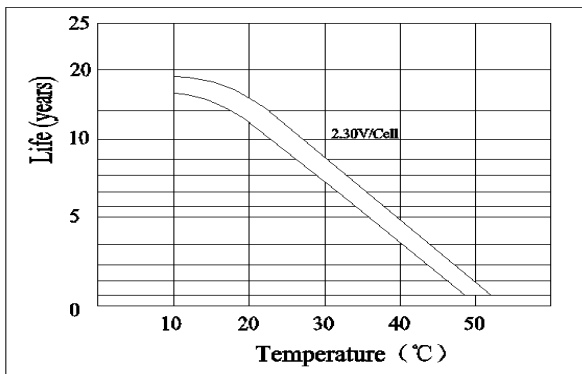

Cycle Life on D.O.D(25°C)

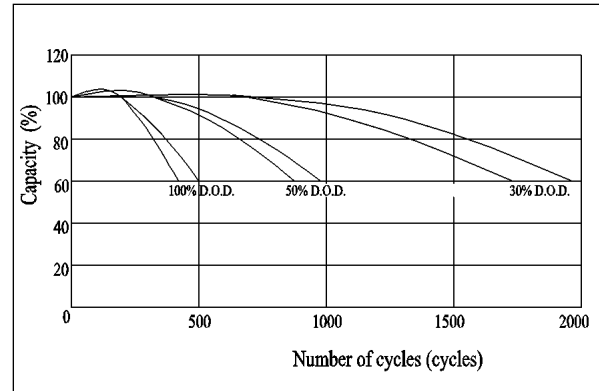

The Relationship for Open Circuit Voltage and Residual Capacity (25°C)

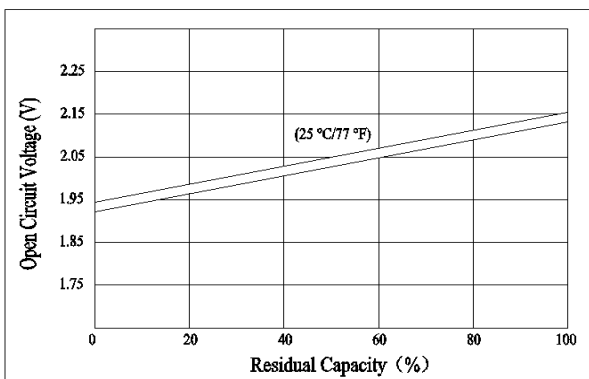

The Relationship for Charging Voltage and Temperature

