

Specifications

Nominal Voltage		2 V
Rated capacity(10HR)		300Ah
Dimension	Length	171±2mm (6.73inch)
	Width	151±2mm (5.94inch)
	Height	330±2mm (12.99inch)
	Total Height	364±2mm (14.33inch)
Approx. Weight		19.5kg (43lbs)±3%

Dimensions

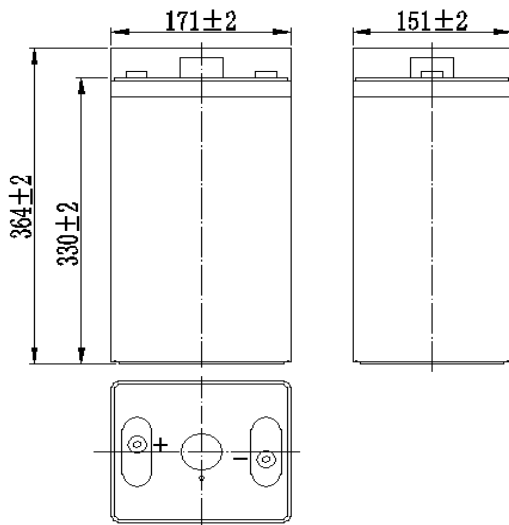

Terminal

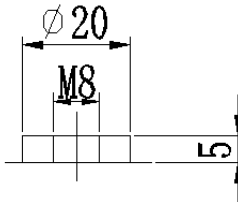

Characteristics

Capacity (25°C)	10HR(1.8V)	300 Ah
	3HR(1.80V)	240Ah
	1HR(1.75V)	180Ah
Terminal type		T20
Internal resistance (Fully charged, 25°C)		Approx. 0.75mΩ
Capacity affected by temperature (10HR)	40°C	102%
	25°C	100%
	0°C	85%
	-15°C	65%
Self-discharge (25°C)	3 month	Remaining Capacity: 91%
	6 month	Remaining Capacity: 82%
	12 month	Remaining Capacity: 65%
Nominal operating temperature		25°C ± 3°C (77°F ± 5°F)
Operating temperature range	Discharge	-15°C ~ 50°C (5°F ~ 122°F)
	Charge	-10°C ~ 50°C (14°F ~ 122°F)
	Storage	-20°C ~ 50°C (-4°F ~ 122°F)
Float charging voltage(25°C)		2.25 to 2.30V Temperature compensation: -3mV/°C
Cyclic charging voltage(25°C)		2.40 to 2.50V Temperature compensation: -5mV/°C
Maximum charging current		60A
Maximum discharge current		2100A(5 sec.)
Designed floating life(20°C)		15 years

Construction

Component	Positive plate	Negative plate	Container	Cover	Separator	Electrolyte	Safety valve	Terminal
Raw material	Lead dioxide	Lead	ABS	ABS	AGM	Sulfuric acid	Rubber	Copper

Constant Current Discharge Characteristics (A, 25°C)

F.V/TIME	15min	30min	60min	2h	3h	4h	5h	6h	8h	10h	20h
1.60V	445	291	202	118	84.9	67.9	58.4	50.3	39.7	32.7	17.3
1.65V	434	285	196	117	84.4	67.5	58.1	50.0	39.4	32.7	17.2
1.70V	418	277	190	116	83.8	67.0	57.7	49.6	39.2	32.6	17.2
1.75V	404	270	183	114	83.2	66.6	57.3	49.3	38.9	32.4	17.1
1.80V	383	260	177	112	80.7	64.6	55.6	47.8	37.7	32.2	17.0

Constant Power Discharge Characteristics (Watt, 25°C)

F.V/TIME	15min	30min	60min	2h	3h	4h	5h	6h	8h	10h	20h
1.60V	814	545	383	228	166	133	115	99.0	78.9	65.2	34.5
1.65V	794	534	372	226	165	132	114	98.4	78.5	65.0	34.5
1.70V	765	517	360	224	164	131	114	97.8	77.9	64.8	34.4
1.75V	739	505	349	221	163	130	113	97.1	77.4	64.4	34.2
1.80V	700	486	337	215	158	127	109	94.2	75.1	64.0	33.9

Note: The above characteristics data can be obtained within three charge/discharge cycles.

Discharge Characteristics(25°C)

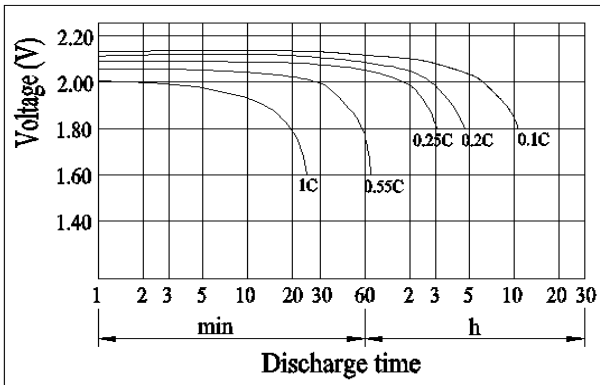

Charging Characteristics(25°C)

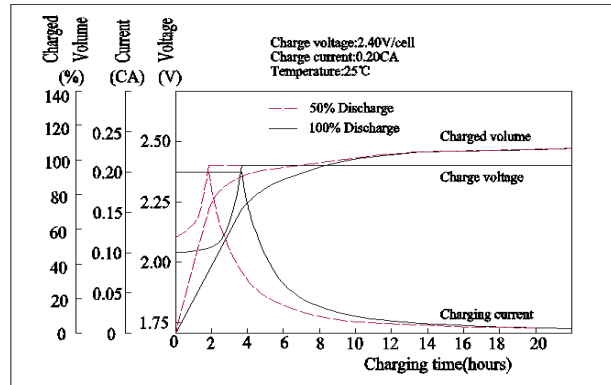

Effect of Temperature on Capacity

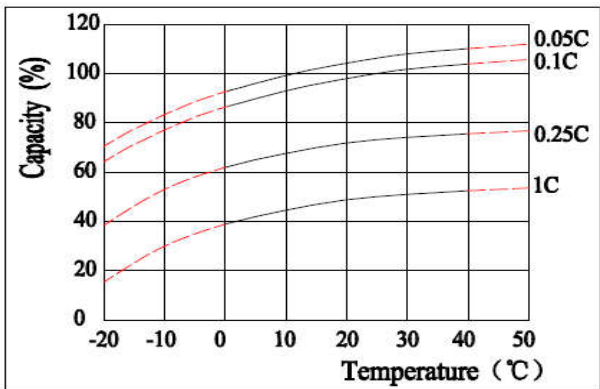

Self-discharge Characteristics

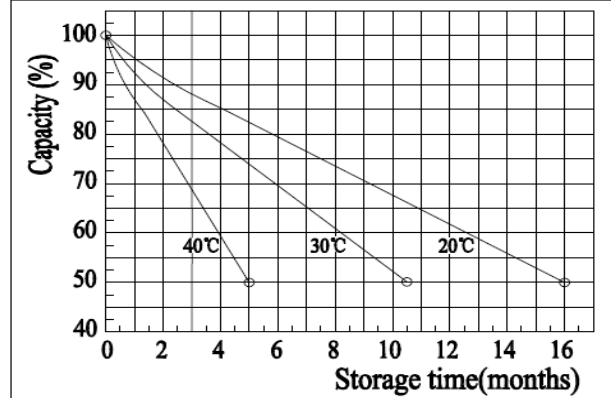

Floating Life on Temperature

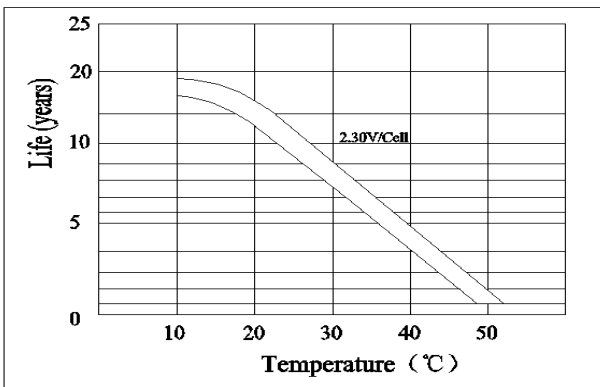

Cycle Life on D.O.D(25°C)

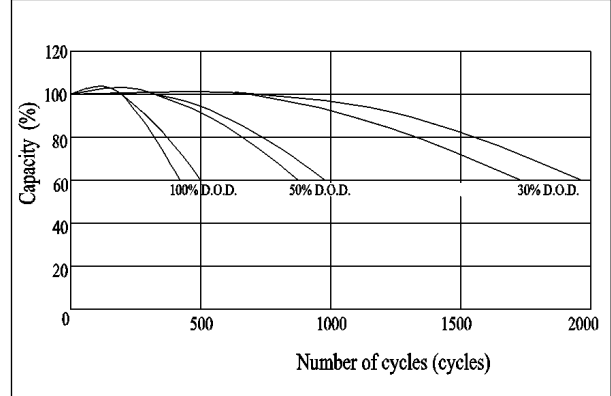

The Relationship for Open Circuit Voltage and Residual Capacity (25°C)

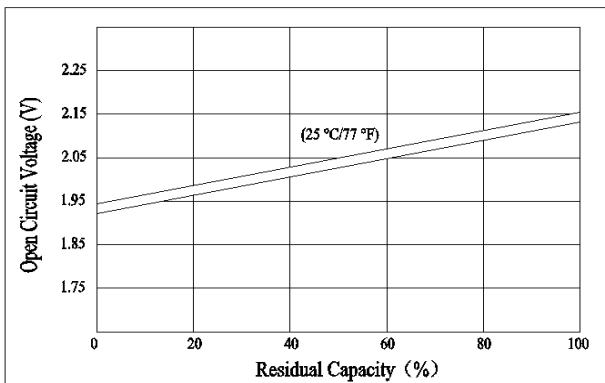

The Relationship for Charging Voltage and Temperature

