

### Specifications

Nominal Voltage		2 V
Rated capacity(10HR)		100Ah
Dimension	Length	171±2mm (6.73inch)
	Width	72±1mm (2.83inch)
	Height	205±2mm (8.07inch)
	Total Height	210±2mm (8.27inch)
Approx. Weight		5.3kg (11.7lbs)±4%

### Dimensions

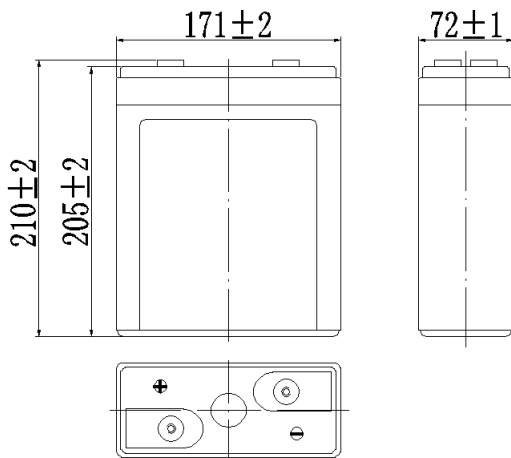

### Terminal

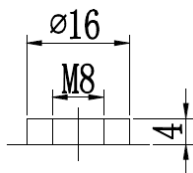

### Characteristics

Capacity (25°C)	10HR(1.8V)	100 Ah
	3HR(1.80V)	75Ah
	1HR(1.75V)	55Ah
Terminal type		T16
Internal resistance (Fully charged, 25°C)		Approx. 0.8mΩ
Capacity affected by temperature (10HR)	40°C	102%
	25°C	100%
	0°C	85%
	-15°C	65%
Self-discharge (25°C)	3 month	Remaining Capacity: 91%
	6 month	Remaining Capacity: 82%
	12 month	Remaining Capacity: 65%
Nominal operating temperature		25°C ± 3°C (77°F ± 5°F)
Operating temperature range	Discharge	-15°C ~ 50°C (5°F ~ 122°F)
	Charge	-10°C ~ 50°C (14°F ~ 122°F)
	Storage	-20°C ~ 50°C (-4°F ~ 122°F)
Float charging voltage(25°C)		2.25 to 2.30V Temperature compensation: -3mV/°C
Cyclic charging voltage(25°C)		2.40 to 2.50V Temperature compensation: -5mV/°C
Maximum charging current		30A
Maximum discharge current		800A(5 sec.)
Designed floating life(20°C)		10 years

### Construction

Component	Positive plate	Negative plate	Container	Cover	Separator	Electrolyte	Safety valve	Terminal
Raw material	Lead dioxide	Lead	ABS	ABS	AGM	Sulfuric acid	Rubber	Copper

### Constant Current Discharge Characteristics (A, 25°C)

F.V/TIME	10min	15min	30min	60min	2h	3h	4h	5h	8h	10h	20h
1.60V	218	168	101	61.8	36.5	26.3	21.0	18.0	12.3	10.2	5.40
1.65V	211	164	98.5	60.9	36.3	26.2	20.9	17.8	12.3	10.2	5.38
1.70V	203	158	95.5	59.3	36.0	26.0	20.7	17.7	12.2	10.1	5.37
1.75V	194	153	93.2	57.5	35.5	25.8	20.6	17.6	12.1	10.1	5.34
1.80V	183	144	89.7	55.6	34.6	25.0	20.0	17.1	11.7	10.0	5.30

### Constant Power Discharge Characteristics (Watt, 25°C)

F.V/TIME	10min	15min	30min	60min	2h	3h	4h	5h	8h	10h	20h
1.60V	392	307	188	117	70.5	51.6	41.2	35.4	24.4	20.3	10.8
1.65V	381	300	184	116	70.1	51.3	40.9	35.2	24.3	20.2	10.8
1.70V	365	289	179	113	69.5	50.9	40.7	34.9	24.1	20.2	10.7
1.75V	349	279	174	109	68.4	50.6	40.4	34.7	24.0	20.0	10.7
1.80V	330	264	168	106	66.7	49.1	39.2	33.6	23.2	19.9	10.6

Note: The above characteristics data can be obtained within three charge/discharge cycles.

## Sealed Lead-Acid Batteries

Discharge Characteristics(25°C)

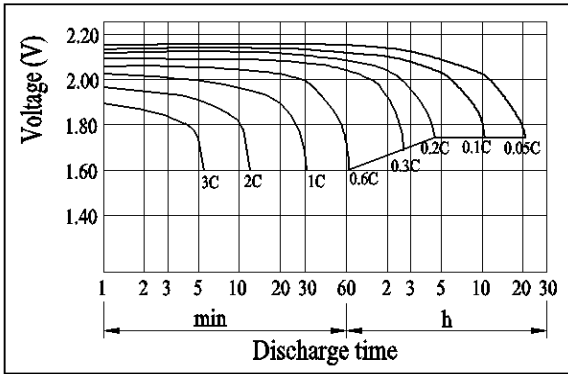

Charging Characteristics(25°C)

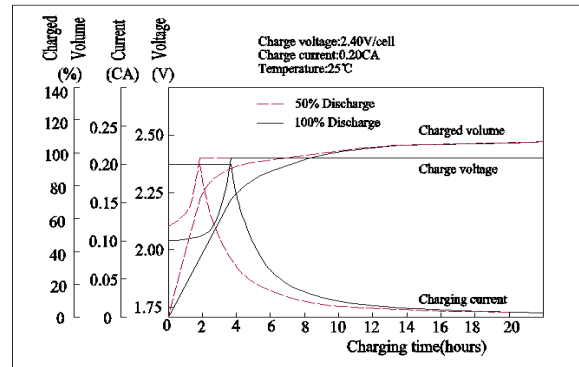

Effect of Temperature on Capacity

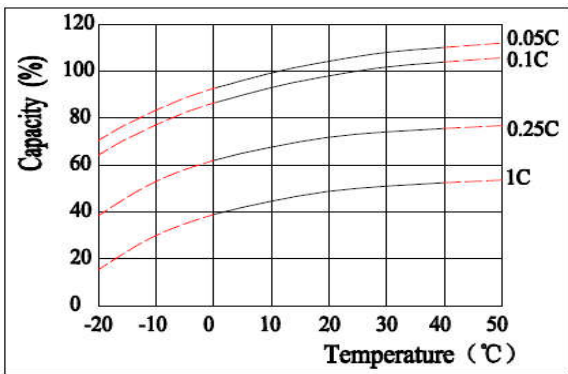

Self-discharge Characteristics

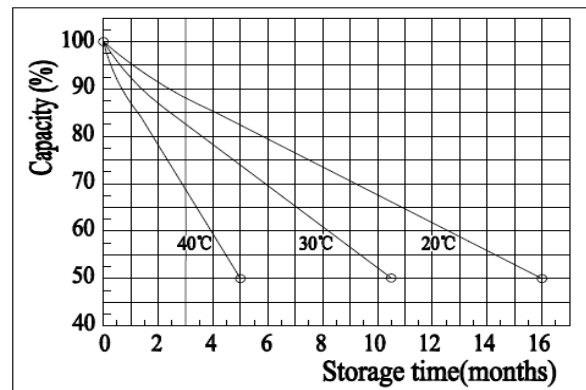

Floating Life on Temperature

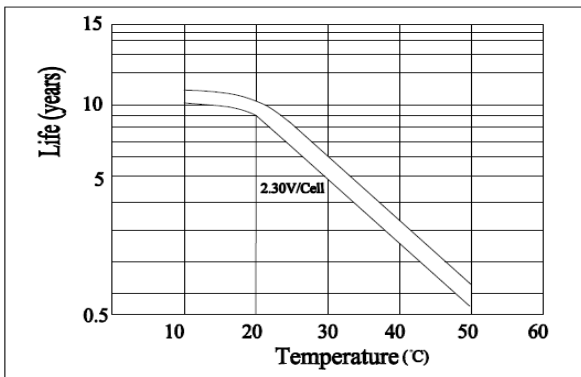

Cycle Life on D.O.D.(25°C)

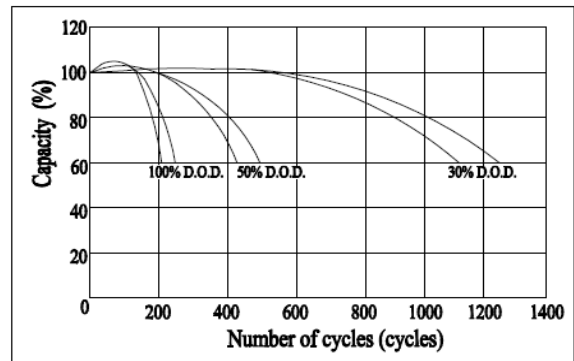

The Relationship for Open Circuit Voltage and Residual Capacity (25°C)

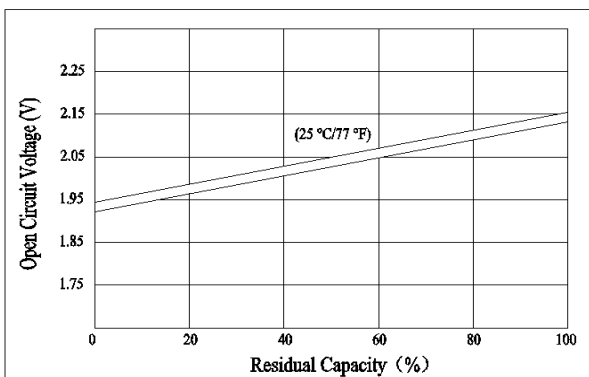

The Relationship for Charging Voltage and Temperature

